

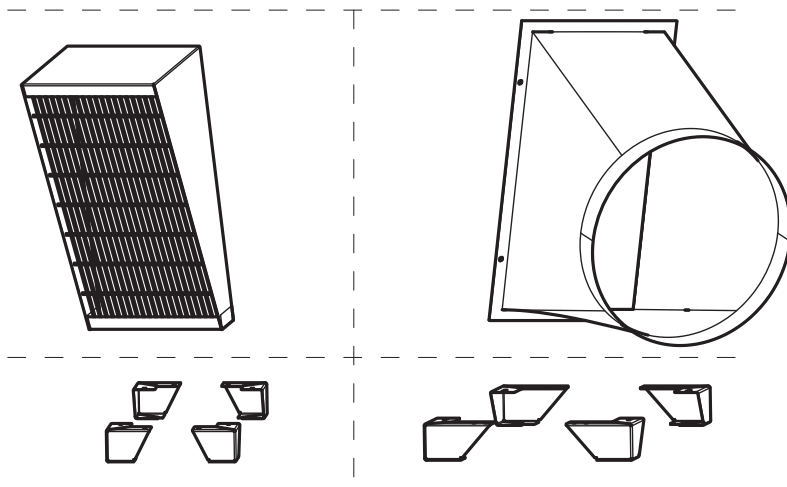

VORT QBK - SAL KC ACCESSORI / ACCESSORIES



COD. 5471.084.276

14.11.2015

VORTICE LIMITED
Beeches House - Eastern Avenue
Burton on Trent
DE13 0BB
Tel. (+44) 1283-492949
Fax (+44) 1283-544121
UNITED KINGDOM

VORTICE FRANCE
15/33 Rue Le Corbusier
Europarc
94046 CRETEIL Cedex
Tel. (+33) 1-55.12.50.00
Fax (+33) 1-55.12.50.01
FRANCE

VORTICE ELETTROSOCIALI S.p.A.
Strada Cerca, 2 - frazione di Zoate
20067 TRIBIANO (MI)
Tel. (+39) 02-90.69.91
Fax (+39) 02-90.64.625
ITALIA

Piedi in metallo

Mounting feet

VORT QBK-SAL KC 315	24.204
VORT QBK-SAL KC 355	24.204
VORT QBK-SAL KC 400	24.204

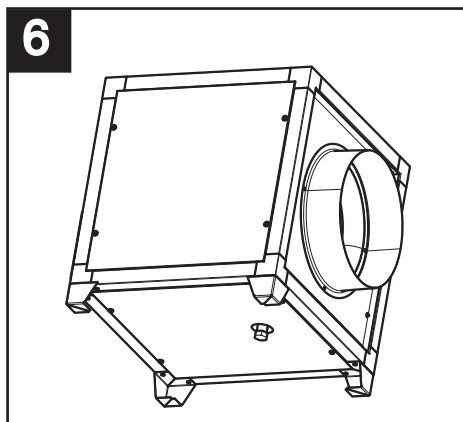
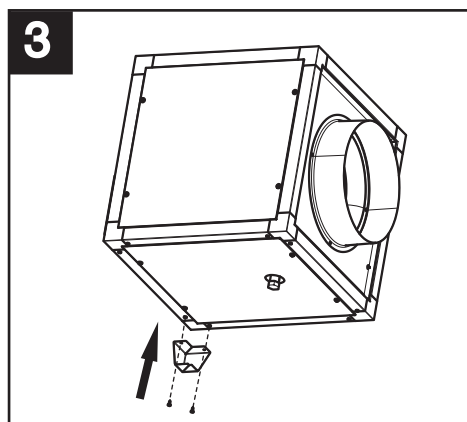
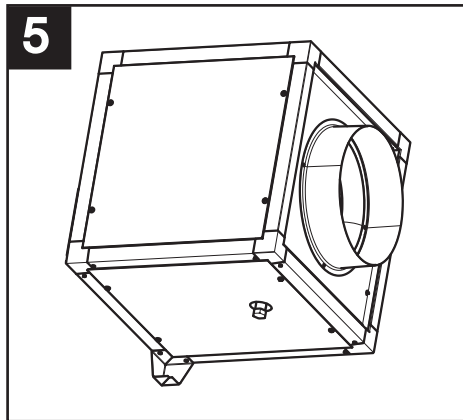
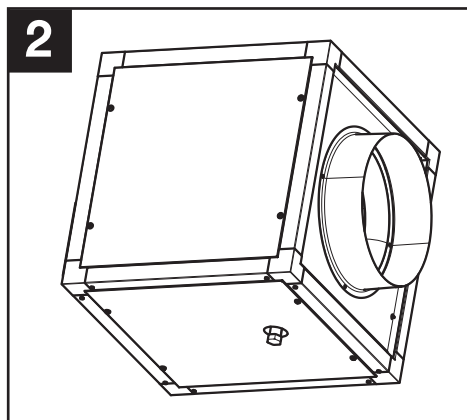
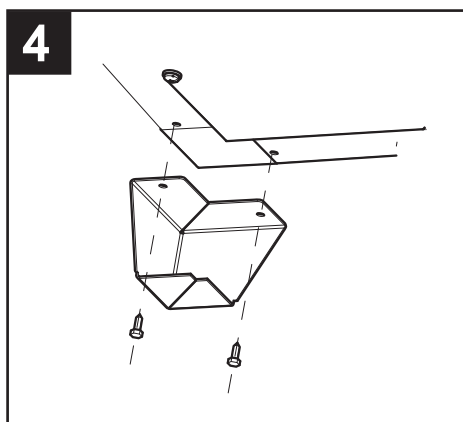
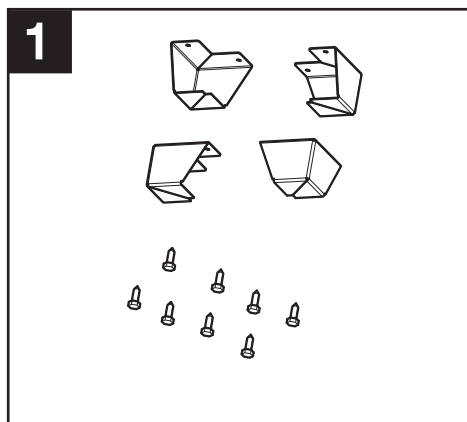

Piedi in metallo

Mounting feet

VORT QBK-SAL KC 500	24.144
VORT QBK-SAL KC 560	24.144

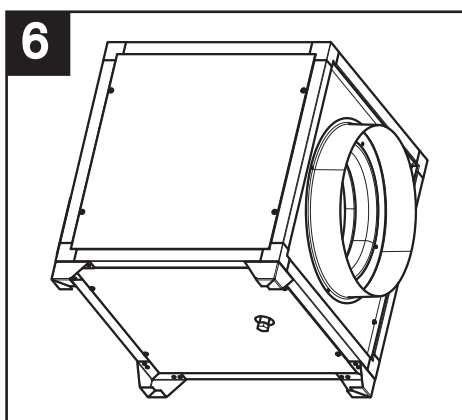
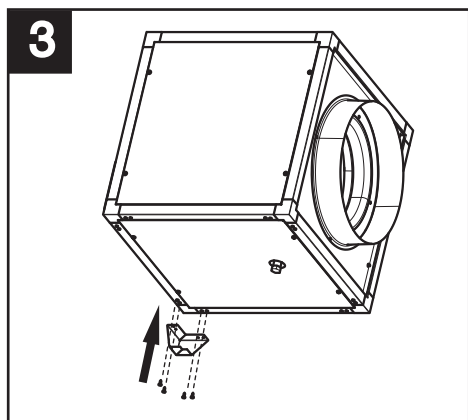
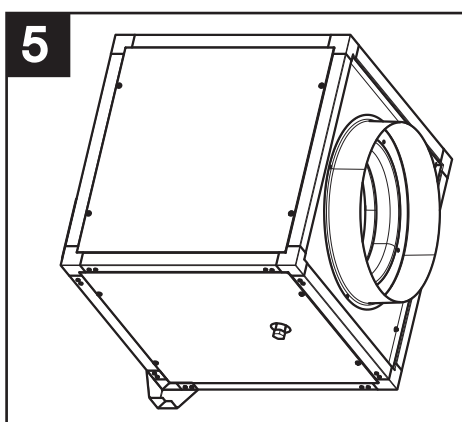
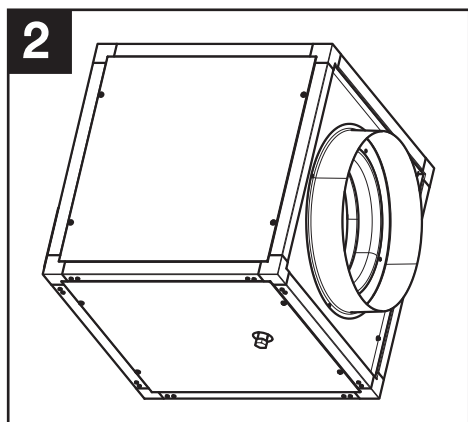
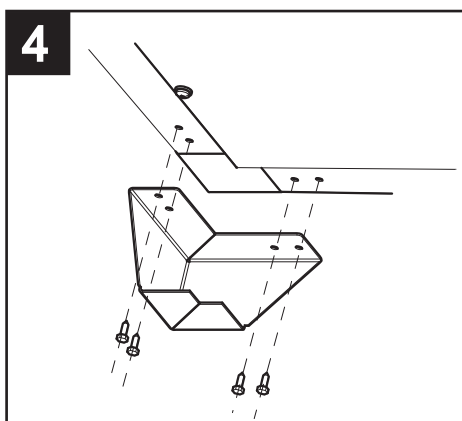
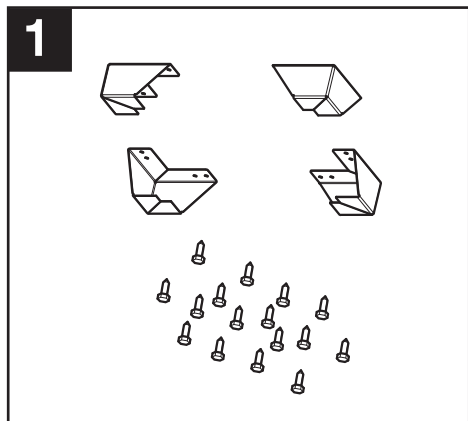

Piedi antivibranti

Anti vibration dampers

VORT QBK-SAL KC 315	24.188
VORT QBK-SAL KC 355	24.188
VORT QBK-SAL KC 400	24.190
VORT QBK-SAL KC 500	24.190
VORT QBK-SAL KC 560	24.190

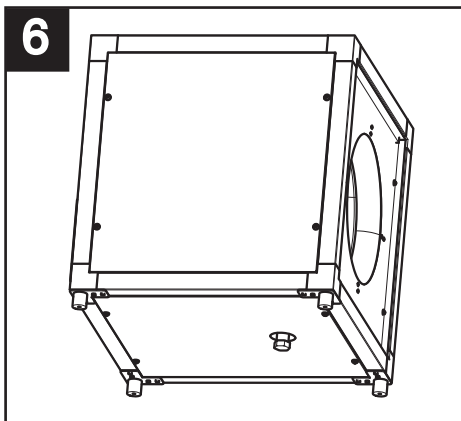
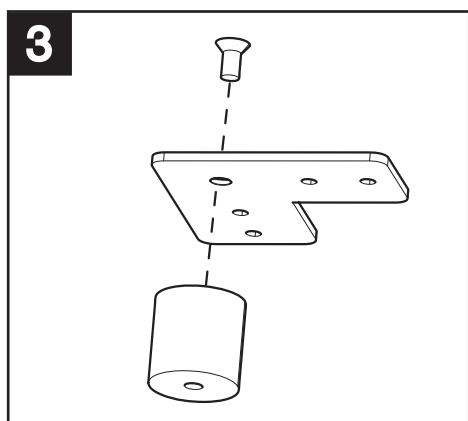
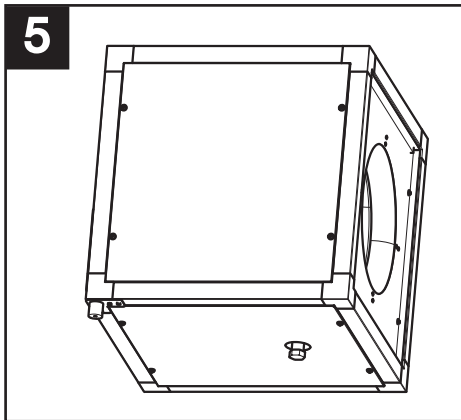
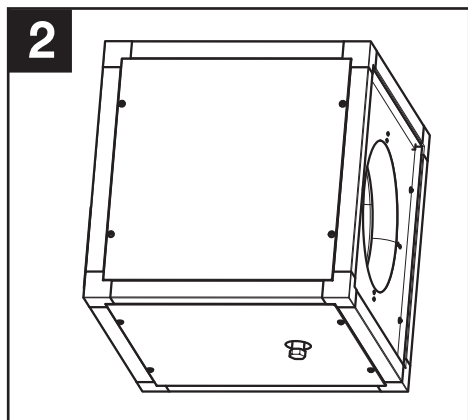
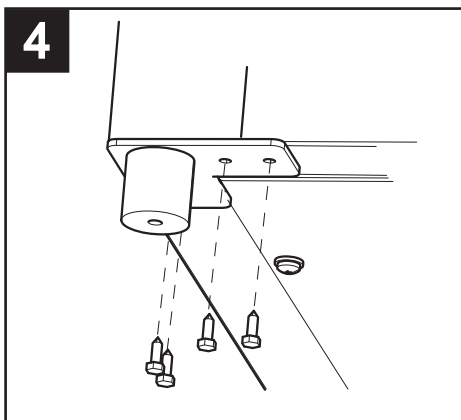
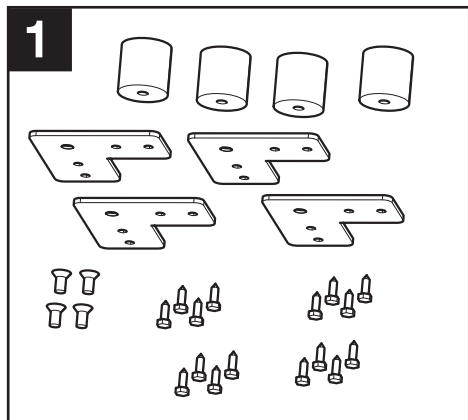

Parapioggia

External rain cover

VORT QBK-SAL KC 315	24.192
VORT QBK-SAL KC 355	24.193
VORT QBK-SAL KC 400	24.194
VORT QBK-SAL KC 500	24.195
VORT QBK-SAL KC 560	24.137

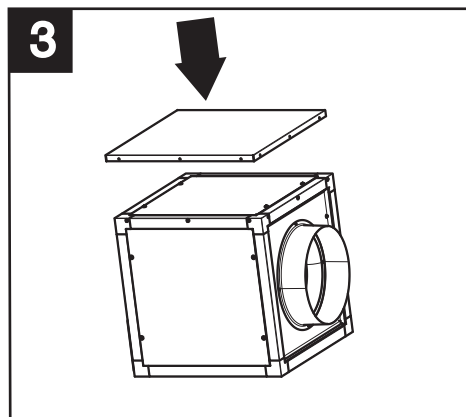
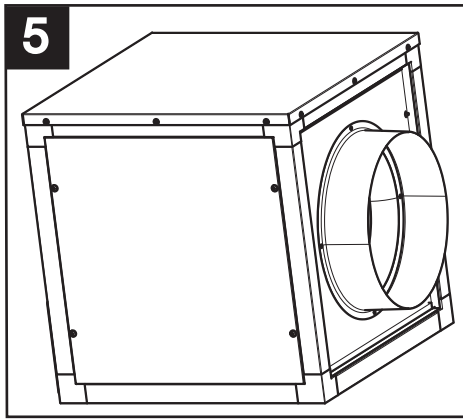
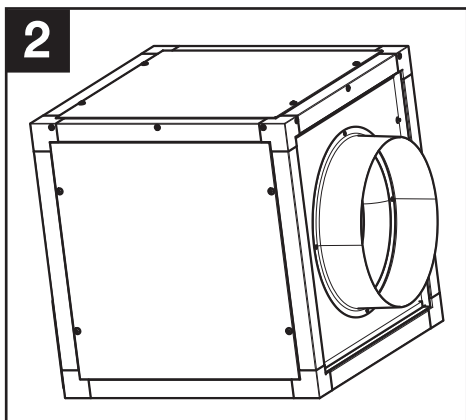
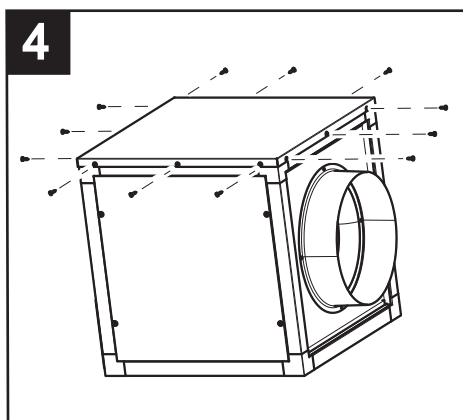
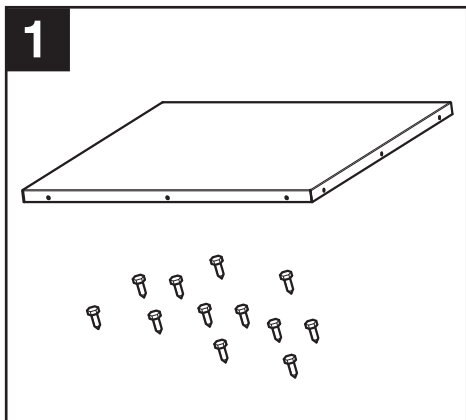

Protezione scarico Angled discharge section

VORT QBK-SAL KC 315	24.196
VORT QBK-SAL KC 355	24.197
VORT QBK-SAL KC 400	24.198
VORT QBK-SAL KC 500	24.199
VORT QBK-SAL KC 560	24.138

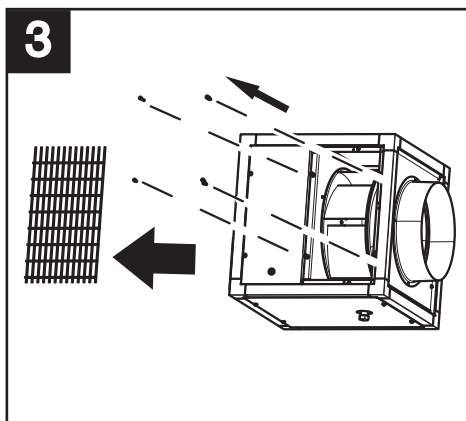
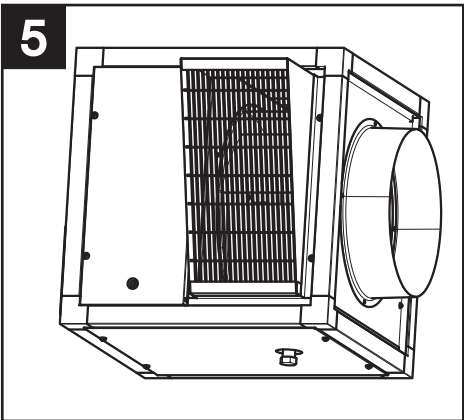
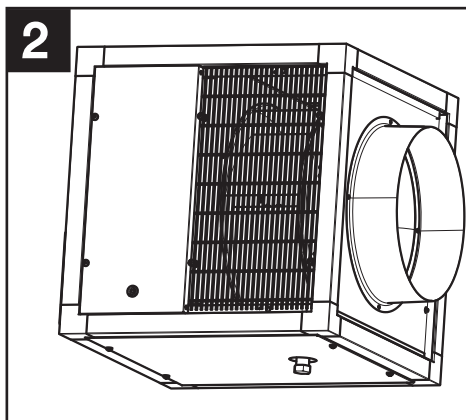
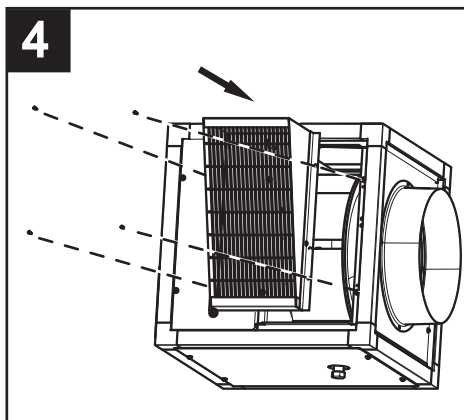
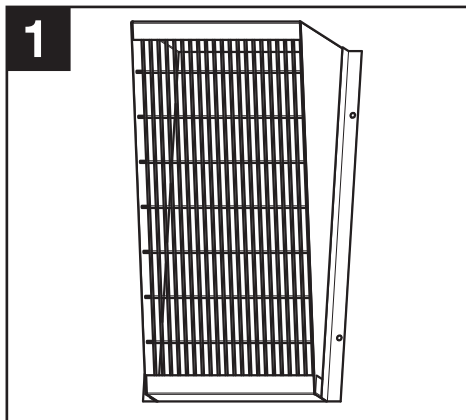

Raccordo rettangolare/tondo

Circular discharge adaptor

VORT QBK-SAL KC 315	24.184
VORT QBK-SAL KC 355	24.185
VORT QBK-SAL KC 400	24.186
VORT QBK-SAL KC 500	24.187
VORT QBK-SAL KC 560	24.135

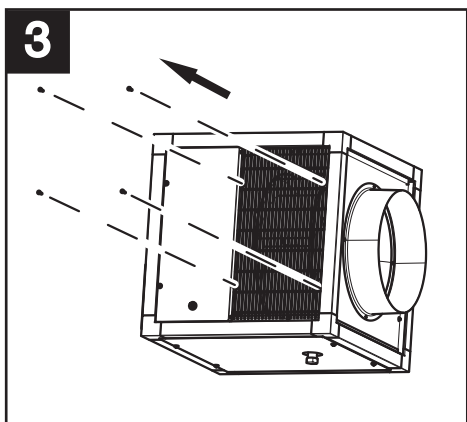
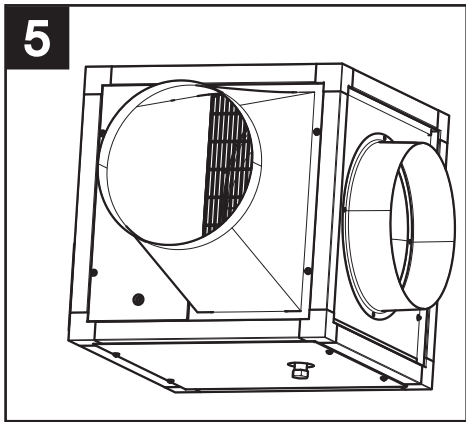
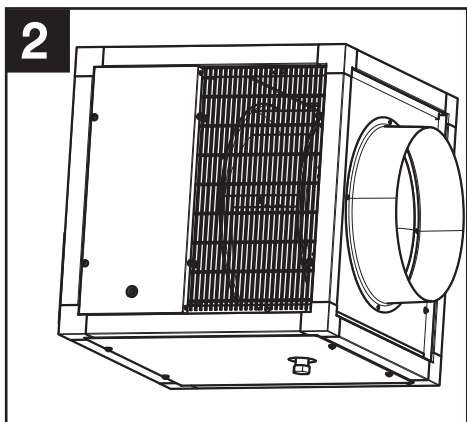
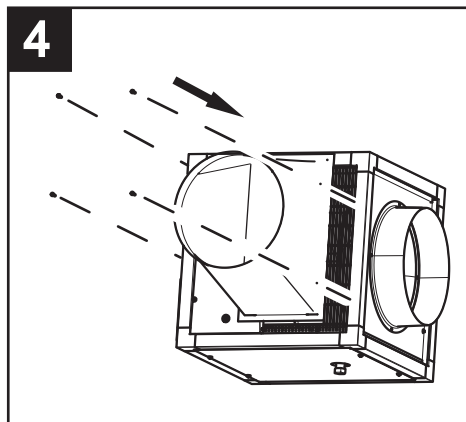
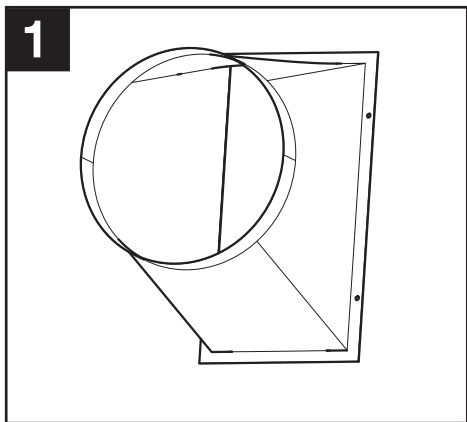



La Vortice S.p.A. si riserva il diritto di apportare tutte le varianti migliorative ai prodotti in corso di vendita.
Vortice S.p.A. reserves the right to make improvements to products at any time and without prior notice.