

Technical Data Sheet

CODE 60641

GORDON W 40/16" ET

Oscillating table, wall-mounting and pedestal fans



Certifications



TECHNICAL AND PERFORMANCE DATA

Absorbed Current max (A)	0,19	Airflow speed at max speed (m/s)	1,61
Absorbed Power max (W)	40	Delivery max (m ³ /h)	4000
Frequency (Hz)	50	Delivery max (m ³ /min)	66,67
Insulation Class	II ^o	Power in stand-by mode (W)	0,4284
IP	20	RPM	1145
Voltage (V)	220-240	Service value (m ³ /min)/W	1,667
Weight (Kg)	3,0	Sound power level Lw [dB(A)]	57,2

DIMENSIONS

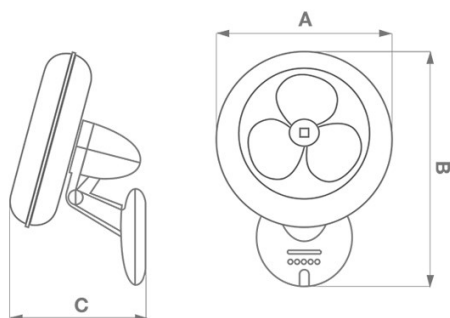

Size A (mm)	460
Size B (mm)	600
Size C (mm)	355

PER INFORMAZIONI:

Servizio al Cliente: tel +39 02 90699395 premendo 1 dopo messaggio registrato (consulenza su prodotti e impianti)

Pre & Post Vendita: fax +39 02 90699302

Email prevendita: prevendita@vortice-italy.com

Technical Data Sheet

CODE 60641

GORDON W 40/16" ET

Oscillating table, wall-mounting and pedestal fans



DESCRIPTION

- Material: plastic resin able to withstand aging induced by exposure to sunlight (UV-resistant), and formulated with an antistatic compound to prevent accumulation of dust.
- Nominal diameter 400 mm
- 3 speed asynchronous motor with shaft turning in self-aligning and self-lubricating bushings; thermal overload protection.
- Motor housing equipped with hinge and clamp knob for adjustment of tilt angle.
- Oscillating mechanism (angle 90°) incorporated into housing, operated by auxiliary asynchronous motor.
- Manual on/off switch and speed selector control; operating status of the fan displayed by luminous indicators located on the base.
- Equipped as standard with IR remote control for switching the fan on and off, selecting the speed, programming the delayed shutoff function (½ h to 7.5 h), and activating the "breeze" option.
- Designed for wall-mounted installation, supplied without power cord.
- Maximum air flow 4,000 m³/h
- IMQ SAFETY and IMQ PERFORMANCE certifications

PER INFORMAZIONI:

Servizio al Cliente: tel +39 02 90699395 premendo 1 dopo messaggio registrato (consulenza su prodotti e impianti)

Pre & Post Vendita: fax +39 02 90699302

Email prevendita: prevendita@vortice-italy.com