

# Technical Data Sheet

CODE 61084

## NORDIK HVLS SUPER BLADE 700/280"

Industrial ceiling fans



### Certifications



### TECHNICAL AND PERFORMANCE DATA

Absorbed Power max (W)	900	Numero pale	5
Diametro nominale (m)	7	Voltage (V)	200-480
Frequency (Hz)	50-60	Weight (Kg)	129
IP	65	Delivery max (m <sup>3</sup> /h)	650.000
Max ambient temperature for continuous operation (°C)	50	Pressione Sonora Lp [dB (A)] in campo libero- 5m	<45
Nominal Current (A)	1,35	RPM max	38

### DIMENSIONS

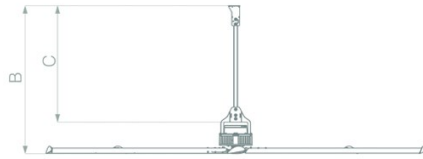

Diametro A (mm)	Ø7000
Size B (mm)	1880
Size C (mm)	1470

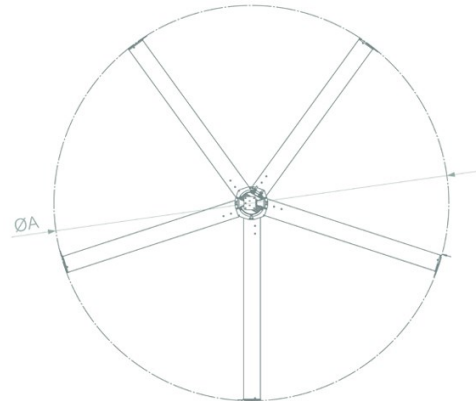

#### PER INFORMAZIONI:

**Servizio al Cliente:** tel +39 02 90699395 premendo 1 dopo messaggio registrato (consulenza su prodotti e impianti)

**Pre & Post Vendita:** fax +39 02 90699302

**Email prevendita:** prevendita@vortice-italy.com

# Technical Data Sheet

CODE 61084

## NORDIK HVLS SUPER BLADE 700/280"



Industrial ceiling fans

### DESCRIPTION

- Nominal diameter of blades: 700 cm.
- Three-phase EC (brushless) motor, thermally insulated.
- Aero-foil blades made of extruded aluminium, equipped with winglets able to decrease the drag caused by wingtip vortices.
- Electronic board allowing power management and functioning control, with EMI/EMC filters to prevent risks of electromagnetic interference, housed in motor covers. The electronic board includes:
  - o A modbus RTU 485 communication port, allowing BMS integration.
  - o An insulated analogic port allowing the fan speed regulation through the external potentiometer (available as optional) or through another 0-10 V signal working device.
- Safety system integrated into the electronic board including protection against overcurrent, short circuit, overheating, overvoltage and under-voltage.
- External Led light able to show possible product malfunctions.
- Steel sheet ceiling installation kit composed of rod (nominal length 1,5 m), a pair of brackets and relative metal parts, supplied as standard.

This kit allows the correct and robust device mounting to the ceiling in the most common installation type.

- Optional kit consisting of a pair of rods, designed to allow greater axial stability. This kit is mandatory in case of:
  - o Strong wind.
  - o Risk of accidental collisions with machines or objects in motion near the ceiling fan.
  - o Presence of birds.
  - o Seismic zone installation or areas characterized by vibrations (ex. Industrial processes involving the use of hammers or industrial presses).
- Adjustable speed through potentiometer or remote control unit (VORT T) able to handle up to 20 units (control units supplied as optional).
- Motor protection class IP65.

### ACCESSORIES



#### VORT T

Code 21137



#### POT

Code 12828



#### POT-I

Code 12832



#### WP

Code 21197



#### USB-C

Code 21198

#### PER INFORMAZIONI:

Servizio al Cliente: tel +39 02 90699395 premendo 1 dopo messaggio registrato (consulenza su prodotti e impianti)

Pre & Post Vendita: fax +39 02 90699302

Email prevendita: prevendita@vortice-italy.com