

Technical Data Sheet

CODE 11129

MF 150/6" T

Wall axial fans



Certifications



IMQ



CE



IMQ Performance



CCC



EAC



G-Mark



UKCA

TECHNICAL AND PERFORMANCE DATA

Absorbed Current max (A)	0,15	Voltage (V)	220-240
Absorbed Power max (W)	28	Weight (Kg)	0,97
Frequency (Hz)	50	Delivery max (l/s)	93
Insulation Class	II ^o	Delivery max (m ³ /h)	335
IP	X4	Pressure max (mmH2O)	6
Max ambient temperature for continuous operation (°C)	50	Pressure max (Pa)	59
Nominal Diameter (mm)	160	RPM	2100
Ø Discharge Hole (mm)	156	Sound Pressure level Lp [dB (A)] 3m	40,1

DIMENSIONS

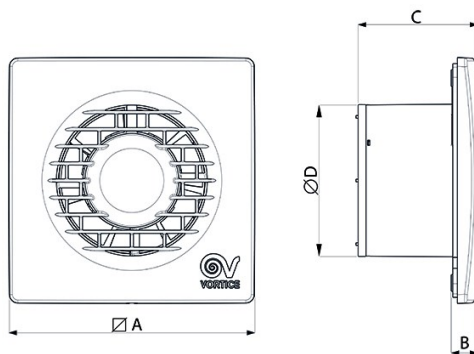

Size A (mm)	214
Size B (mm)	17
Size C (mm)	96
Size D (mm)	156

PER INFORMAZIONI:

Servizio al Cliente: tel +39 02 90699395 premendo 1 dopo messaggio registrato (consulenza su prodotti e impianti)

Pre & Post Vendita: fax +39 02 90699302

Email prevendita: prevendita@vortice-italy.com

Technical Data Sheet

CODE 11129

MF 150/6" T

Wall axial fans



DESCRIPTION

- Material: UV resistant plastic (prevents ageing caused by exposure to sunlight).
- Nominal diameter 150 mm.
- Motor protected against thermal overload, with shaft turning in self-lubricating bushings, coupled to screw type thermoplastic impeller with wing profile blades.
- Maximum air flow: 335 m³/h.
- Equipped with electronic timer designed to shut off the motor automatically after a set interval, selectable during installation in the range 3'-20' (default setting 3').
- Non-return damper fitted to outlet port.
- IMQ SAFETY and IMQ PERFORMANCE certifications.
- Vortice speed controller.

CURVES

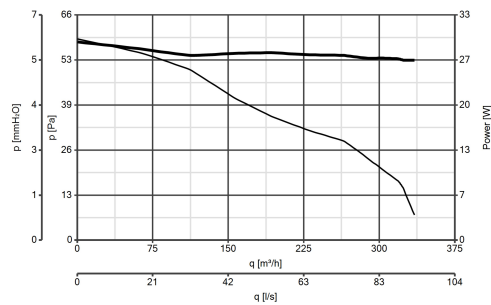

ACCESSORIES

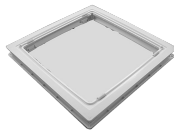

SF 150

Code 22164

PER INFORMAZIONI:

Servizio al Cliente: tel +39 02 90699395 premendo 1 dopo messaggio registrato (consulenza su prodotti e impianti)

Pre & Post Vendita: fax +39 02 90699302

Email prevendita: prevendita@vortice-italy.com